

## KSC5402D/KSC5402DT

### High Voltage High Speed Power Switch Application

- Wide Safe Operating Area
- Built-in Free Wheeling Diode
- Suitable for Electronic Ballast Application
- Small Variance in Storage Time
- Two Package Choices; D-PAK or TO-220

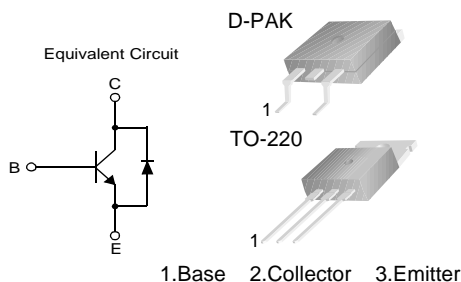

### NPN Silicon Transistor Planar Silicon Transistor

#### Absolute Maximum Ratings $T_C=25^\circ\text{C}$ unless otherwise noted

| Symbol    | Parameter   | Value      | Units            |
|-----------|---|------------|------------------|
| $V_{CBO}$ | Collector-Base Voltage  | 1000       | V                |
| $V_{CEO}$ | Collector-Emitter Voltage   | 450        | V                |
| $V_{EBO}$ | Emitter-Base Voltage  | 12         | V                |
| $I_C$     | Collector Current (DC)  | 2          | A                |
| $I_{CP}$  | *Collector Current (Pulse)  | 5          | A                |
| $I_B$     | Base Current (DC)   | 1          | A                |
| $I_{BP}$  | *Base Current (Pulse)   | 2          | A                |
| $P_C$     | Power Dissipation( $T_C=25^\circ\text{C}$ ) : D-PAK *<br>: TO-220 | 30<br>50   | W                |
| $T_J$     | Junction Temperature  | 150        | $^\circ\text{C}$ |
| $T_{STG}$ | Storage Temperature   | - 65 ~ 150 | $^\circ\text{C}$ |

\* Pulse Test: Pulse Width=5ms, Duty Cycle  $\leq$  10%

#### Thermal Characteristics $T_C=25^\circ\text{C}$ unless otherwise noted

| Symbol          | Characteristics  | Rating              |       | Unit   |                           |
|-----------------|--|---------------------|-------|--------|---------------------------|
|                 |  | TO-220              | D-PAK |        |                           |
| $R_{\theta jc}$ | Thermal Resistance   | Junction to Case    | 2.5   | 4.17 * | $^\circ\text{C}/\text{W}$ |
| $R_{\theta ja}$ |  | Junction to Ambient | 62.5  | 50     |                           |
| $T_L$           | Maximum Lead Temperature for Soldering Purpose<br>; 1/8" from Case for 5 Seconds |                     | 270   | 270    | $^\circ\text{C}$          |

\* Mounted on 1" square PCB (FR4 ro G-10 Material)

**Electrical Characteristics**  $T_C=25^\circ\text{C}$  unless otherwise noted

| Symbol        | Parameter                            | Test Condition                            | Min.                    | Typ. | Max. | Units         |
|---------------|--------------------------------------|---|-------------------------|------|------|---------------|
| $BV_{CBO}$    | Collector-Base Breakdown Voltage     | $I_C=1\text{mA}, I_E=0$                   | 1000                    | 1090 |      | V             |
| $BV_{CEO}$    | Collector-Emitter Breakdown Voltage  | $I_C=5\text{mA}, I_B=0$                   | 450                     | 525  |      | V             |
| $BV_{EBO}$    | Emitter-Base Breakdown Voltage       | $I_E=1\text{mA}, I_C=0$                   | 12                      | 14   |      | V             |
| $I_{CES}$     | Collector Cut-off Current            | $V_{CES}=1000\text{V}, I_{EB}=0$          | $T_C=25^\circ\text{C}$  | 0.03 | 100  | $\mu\text{A}$ |
|               |                                      |   | $T_C=125^\circ\text{C}$ | 1.2  | 500  |               |
| $I_{CEO}$     | Collector Cut-off Current            | $V_{CE}=450\text{V}, V_B=0$               | $T_C=25^\circ\text{C}$  | 0.3  | 100  | $\mu\text{A}$ |
|               |                                      |   | $T_C=125^\circ\text{C}$ | 15   | 500  |               |
| $I_{EBO}$     | Emitter Cut-off Current              | $V_{EB}=10\text{V}, I_C=0$                |                         | 0.01 | 100  | $\mu\text{A}$ |
| $h_{FE}$      | DC Current Gain                      | $V_{CE}=1\text{V}, I_C=0.4\text{A}$       | $T_C=25^\circ\text{C}$  | 14   | 29   |               |
|               |                                      |   | $T_C=125^\circ\text{C}$ | 8    | 17   |               |
|               |                                      | $V_{CE}=1\text{V}, I_C=1\text{A}$         | $T_C=25^\circ\text{C}$  | 6    | 9    |               |
|               |                                      |   | $T_C=125^\circ\text{C}$ | 4    | 6    |               |
| $V_{CE(sat)}$ | Collector-Emitter Saturation Voltage | $I_C=0.4, I_B=0.04\text{A}$               | $T_C=25^\circ\text{C}$  | 0.25 | 0.6  |               |
|               |                                      |   | $T_C=125^\circ\text{C}$ | 0.4  | 1.0  |               |
|               |                                      | $I_C=1\text{A}, I_B=0.2\text{A}$          | $T_C=25^\circ\text{C}$  | 0.3  | 0.75 | V             |
|               |                                      |   | $T_C=125^\circ\text{C}$ | 0.65 | 1.2  | V             |
| $V_{BE(sat)}$ | Base-Emitter Saturation Voltage      | $I_C=0.4\text{A}, I_B=0.04\text{A}$       | $T_C=25^\circ\text{C}$  | 0.78 | 1.0  | V             |
|               |                                      |   | $T_C=125^\circ\text{C}$ | 0.65 | 0.9  | V             |
|               |                                      | $I_C=1\text{A}, I_B=0.2\text{A}$          | $T_C=25^\circ\text{C}$  | 0.85 | 1.1  | V             |
|               |                                      |   | $T_C=125^\circ\text{C}$ | 0.75 | 1.0  | V             |
| $C_{ib}$      | Input Capacitance                    | $V_{EB}=8\text{V}, I_C=0, f=1\text{MHz}$  |                         | 330  | 500  | pF            |
| $C_{ob}$      | Output Capacitance                   | $V_{CB}=10\text{V}, I_E=0, f=1\text{MHz}$ |                         | 35   | 100  | pF            |
| $f_T$         | Current Gain Bandwidth Product       | $I_C=0.5\text{A}, V_{CE}=10\text{V}$      |                         | 11   |      | MHz           |
| $V_F$         | Diode Forward Voltage                | $I_F=1\text{A}$                           | $T_C=25^\circ\text{C}$  | 0.86 | 1.5  | V             |
|               |                                      |   | $T_C=125^\circ\text{C}$ | 0.75 | 1.2  | V             |
|               |                                      | $I_F=0.2\text{A}$                         | $T_C=25^\circ\text{C}$  | 0.6  |      | V             |
|               |                                      |   | $T_C=125^\circ\text{C}$ | 0.8  | 1.3  | V             |
|               |                                      |   | $T_C=125^\circ\text{C}$ | 0.65 |      | V             |

**Electrical Characteristics**  $T_C=25^\circ\text{C}$  unless otherwise noted

| Symbol  | Parameter   | Test Condition   | Min                     | Typ. | Max. | Units |               |
|---|---|--|-------------------------|------|------|-------|---------------|
| $t_{fr}$  | Diode Forward Recovery Time<br>( $di/dt=10\text{A}/\mu\text{s}$ ) | $I_F=0.2\text{A}$  |                         | 540  |      | ns    |               |
|   |   | $I_F=0.4\text{A}$  |                         | 520  |      | ns    |               |
|   |   | $I_F=1\text{A}$  |                         | 480  |      | ns    |               |
| $V_{CE(DSAT)}$  | Dynamic Saturation Voltage  | $I_C=0.4\text{A}$ ,<br>$I_{B1}=40\text{mA}$<br>$V_{CC}=300\text{V}$  | @ $1\mu\text{s}$        |      | 7.5  |       | V             |
|   |   |  | @ $3\mu\text{s}$        |      | 2.5  |       | V             |
|   |   | $I_C=1\text{A}$ ,<br>$I_{B1}=200\text{mA}$<br>$V_{CC}=300$           | @ $1\mu\text{s}$        |      | 11.5 |       | V             |
|   |   |  | @ $3\mu\text{s}$        |      | 1.5  |       | V             |
| RESISTIVE LOAD SWITCHING (D.C. $\leq 10\%$ , Pulse Width= $20\mu\text{s}$ ) |   |  |                         |      |      |       |               |
| $t_{ON}$  | Turn On Time  | $I_C=1\text{A}$ ,<br>$I_{B1}=200\text{mA}$                           | $T_C=25^\circ\text{C}$  |      | 110  | 150   | ns            |
|   |   |  | $T_C=125^\circ\text{C}$ |      | 135  |       | ns            |
| $t_{OFF}$   | Turn Off Time   | $I_{B2}=150\text{mA}$<br>$V_{CC}=300\text{V}$<br>$R_L = 300\Omega$   | $T_C=25^\circ\text{C}$  | 0.95 |      | 1.25  | $\mu\text{s}$ |
|   |   |  | $T_C=125^\circ\text{C}$ |      | 1.4  |       | $\mu\text{s}$ |
| INDUCTIVE LOAD SWITCHING ( $V_{CC}=15\text{V}$ )                            |   |  |                         |      |      |       |               |
| $t_{STG}$   | Storage Time  | $I_C=0.4\text{A}$ ,<br>$I_{B1}=40\text{mA}$                          | $T_C=25^\circ\text{C}$  |      | 0.56 | 0.65  | $\mu\text{s}$ |
|   |   |  | $T_C=125^\circ\text{C}$ |      | 0.7  |       | $\mu\text{s}$ |
| $t_F$   | Fall Time   | $I_{B2}=200\text{mA}$ ,<br>$V_Z=300\text{V}$<br>$L_C=200\text{H}$    | $T_C=25^\circ\text{C}$  |      | 60   | 175   | ns            |
|   |   |  | $T_C=125^\circ\text{C}$ |      | 75   |       | ns            |
| $t_C$   | Cross-over Time   |  | $T_C=25^\circ\text{C}$  |      | 90   | 175   | ns            |
|   |   |  | $T_C=125^\circ\text{C}$ |      | 90   |       | ns            |
| $t_{STG}$   | Storage Time  | $I_C=0.8\text{A}$ ,<br>$I_{B1}=160\text{mA}$                         | $T_C=25^\circ\text{C}$  |      |      | 2.75  | $\mu\text{s}$ |
|   |   |  | $T_C=125^\circ\text{C}$ |      | 3    |       | $\mu\text{s}$ |
| $t_F$   | Fall Time   | $I_{B2}=160\text{mA}$ ,<br>$V_Z=300\text{V}$<br>$L_C=200\text{H}$    | $T_C=25^\circ\text{C}$  |      | 110  | 175   | ns            |
|   |   |  | $T_C=125^\circ\text{C}$ |      | 180  |       | ns            |
| $t_C$   | Cross-over Time   |  | $T_C=25^\circ\text{C}$  |      | 125  | 350   | ns            |
|   |   |  | $T_C=125^\circ\text{C}$ |      | 185  |       | ns            |
| $t_{STG}$   | Storage Time  | $I_C=1\text{A}$ ,<br>$I_{B1}=200\text{mA}$                           | $T_C=25^\circ\text{C}$  |      | 1.1  | 1.2   | $\mu\text{s}$ |
|   |   |  | $T_C=125^\circ\text{C}$ |      | 1.35 |       | $\mu\text{s}$ |
| $t_F$   | Fall Time   | $I_{B2}=500\text{mA}$ ,<br>$V_Z=300\text{V}$<br>$L_C=200\mu\text{H}$ | $T_C=25^\circ\text{C}$  |      | 105  | 150   | ns            |
|   |   |  | $T_C=125^\circ\text{C}$ |      | 75   |       | ns            |
| $t_C$   | Cross-over Time   |  | $T_C=25^\circ\text{C}$  |      | 125  | 150   | ns            |
|   |   |  | $T_C=125^\circ\text{C}$ |      | 100  |       | ns            |

# Typical Characteristics

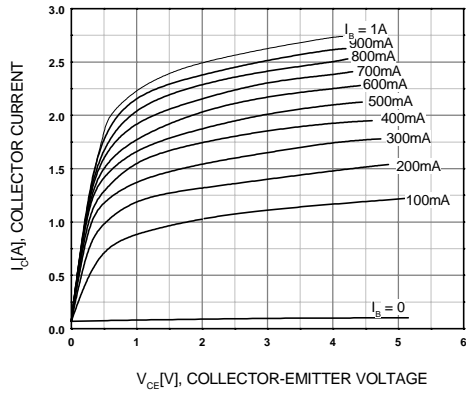

Figure 1. Static Characteristic

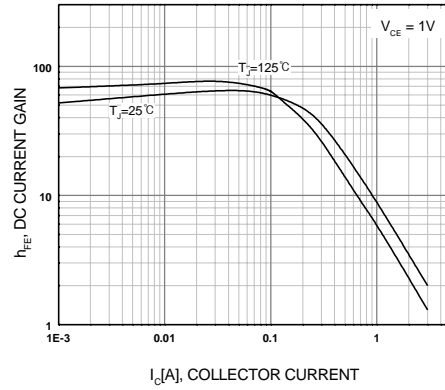

Figure 2. DC current Gain

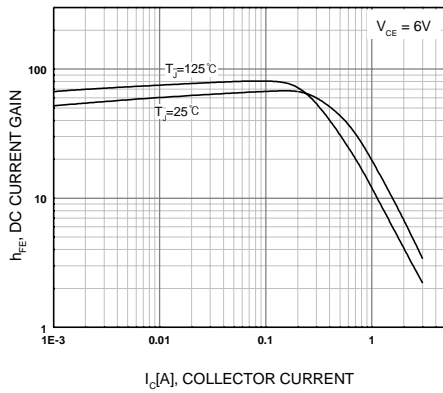

Figure 3. DC current Gain

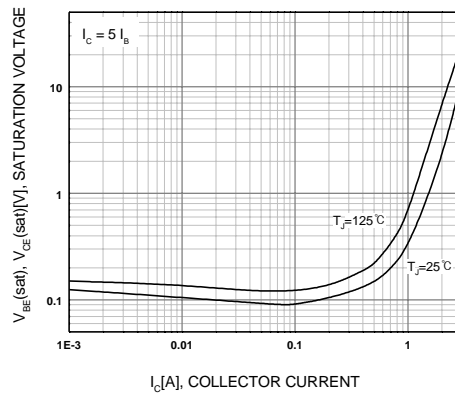

Figure 4. Collector-Emitter Saturation Voltage

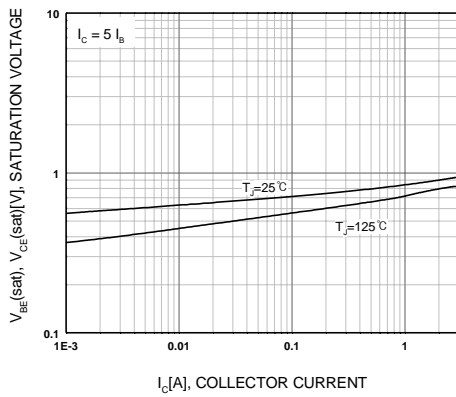

Figure 5. Base-Emitter Saturation Voltage

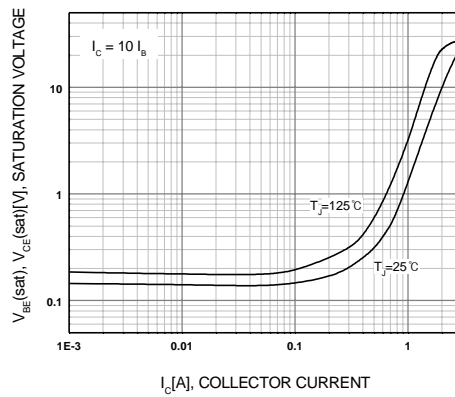

Figure 6. Collector-Emitter Saturation Voltage

Typical Characteristics (Continued)

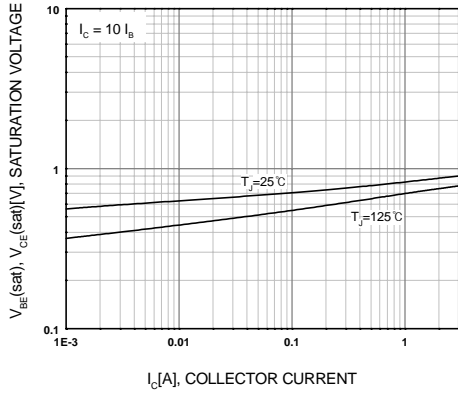

Figure 7. Base-Emitter Saturation Voltage

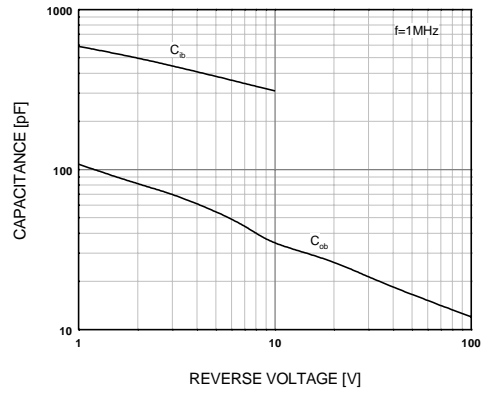

Figure 8. Collector Output Capacitance

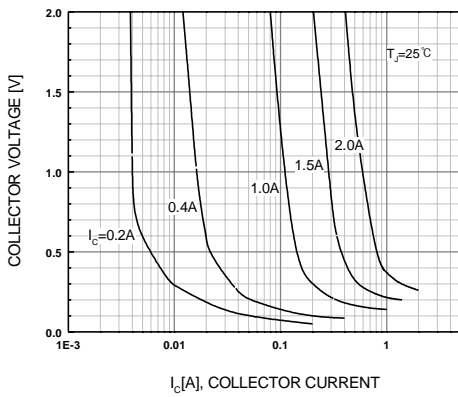

Figure 9. Typical Collector Saturation Region

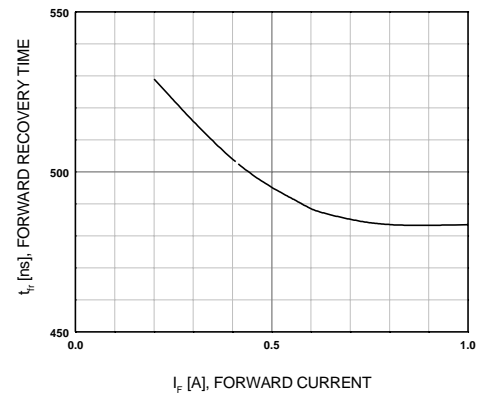

Figure 10. Forward Recovery Time

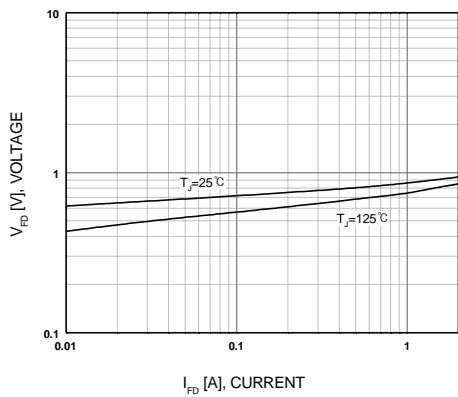

Figure 11. Diode Forward Voltage

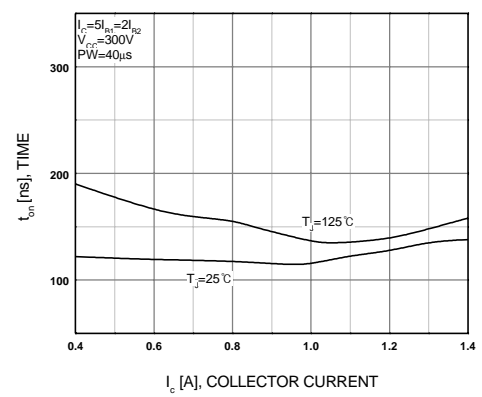

Figure 12. Resistive Switching Time,  $t_{on}$

Typical Characteristics (Continued)

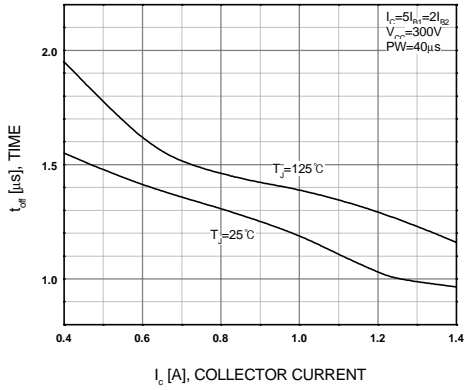

Figure 13. Resistive Switching Time,  $t_{off}$

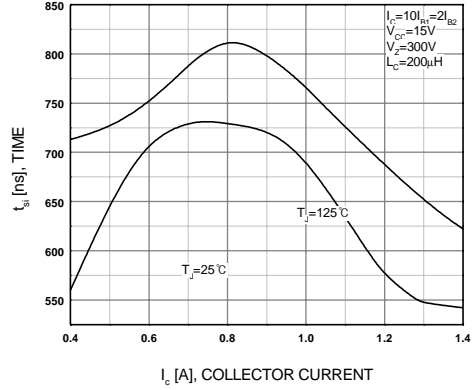

Figure 14. Inductive Switching Time,  $t_{si}$

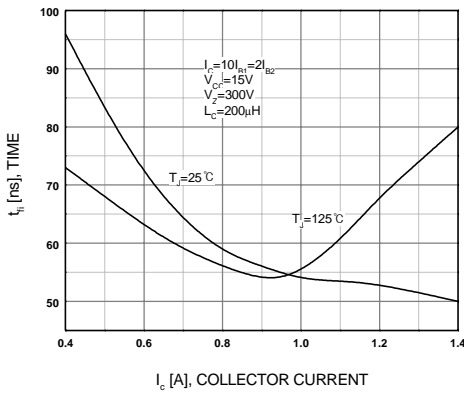

Figure 15. Inductive Switching Time,  $t_{fi}$

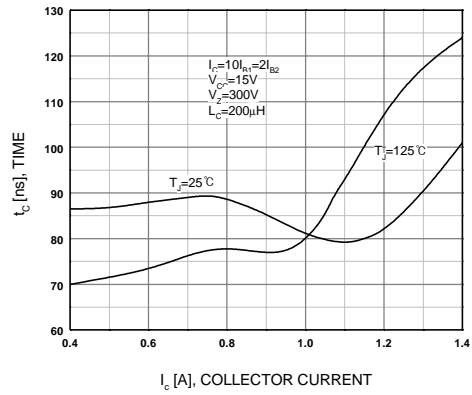

Figure 16. Inductive Switching Time,  $t_c$

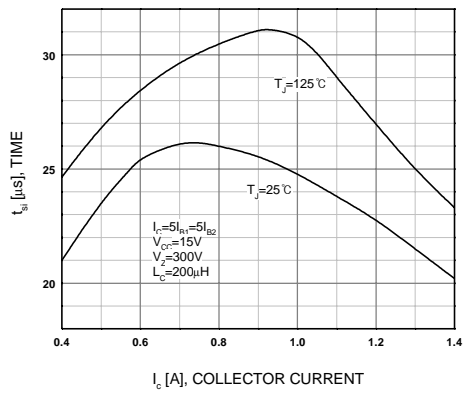

Figure 17. Inductive Switching Time,  $t_{si}$

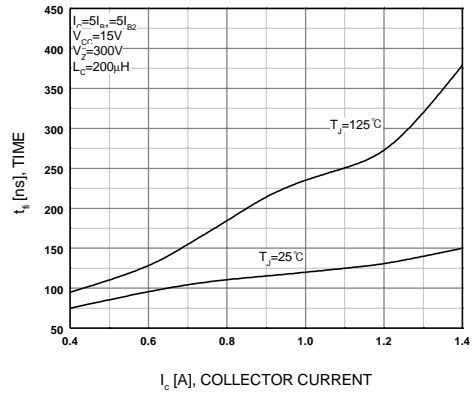

Figure 18. Inductive Switching Time,  $t_{fi}$

Typical Characteristics (Continued)

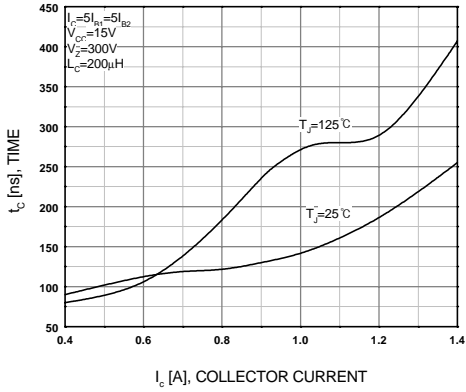

Figure 19. Inductive Switching Time,  $t_c$

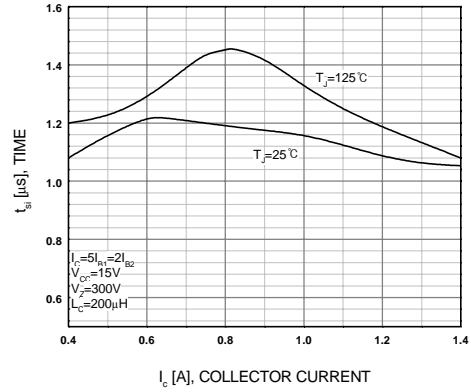

Figure 20. Inductive Switching Time,  $t_{si}$

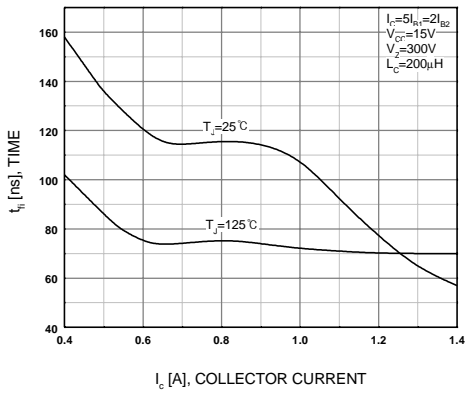

Figure 21. Inductive Switching Time,  $t_{fi}$

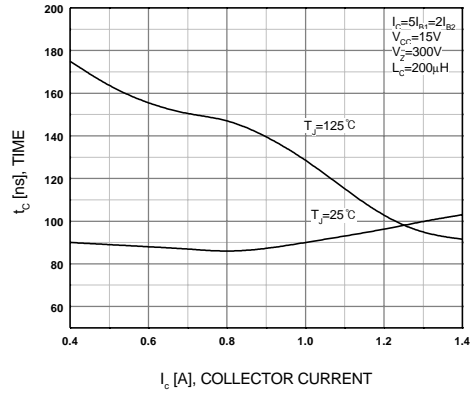

Figure 22. Inductive Switching Time,  $t_c$

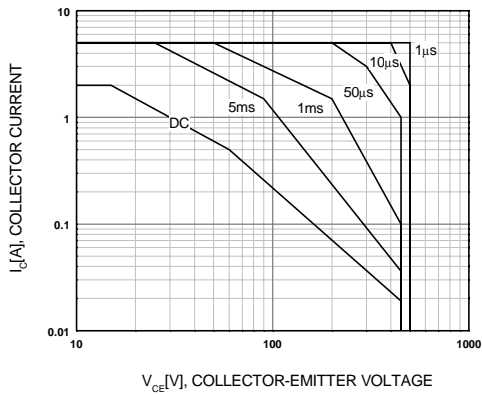

Figure 23. Forward Bias Safe Operating Area

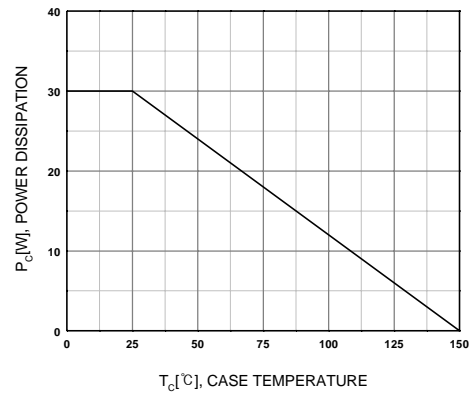
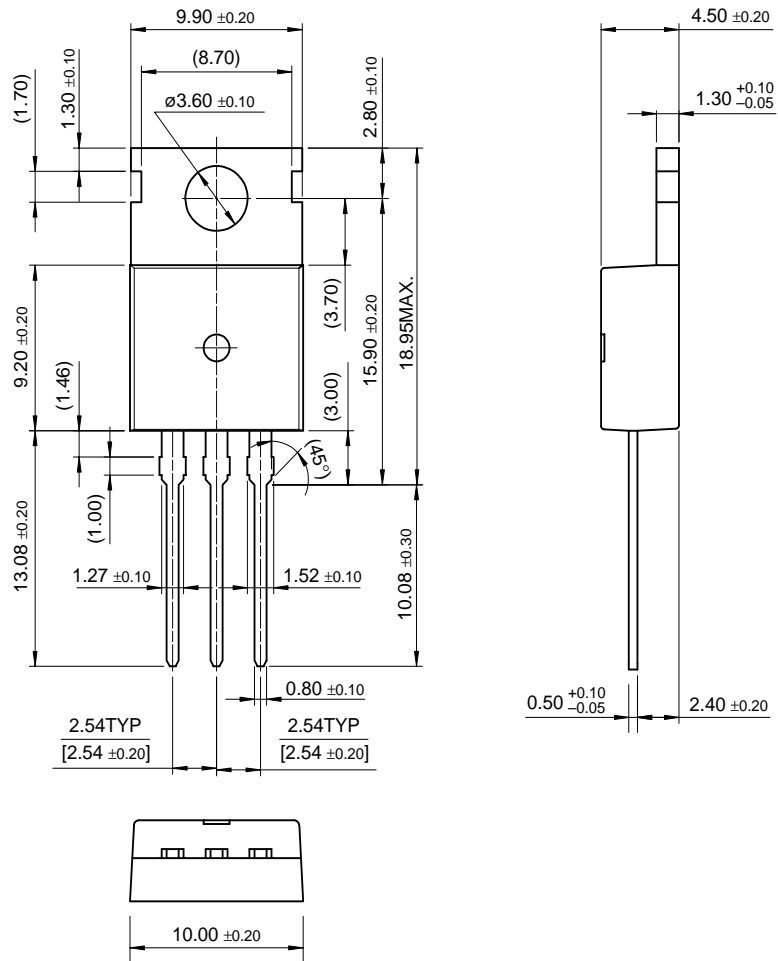

Figure 24. Power Derating

# Package Dimensions

## TO-220



Dimensions in Millimeters

KSC5402D/KSC5402DT



# Package Dimensions (Continued)

## D-PAK

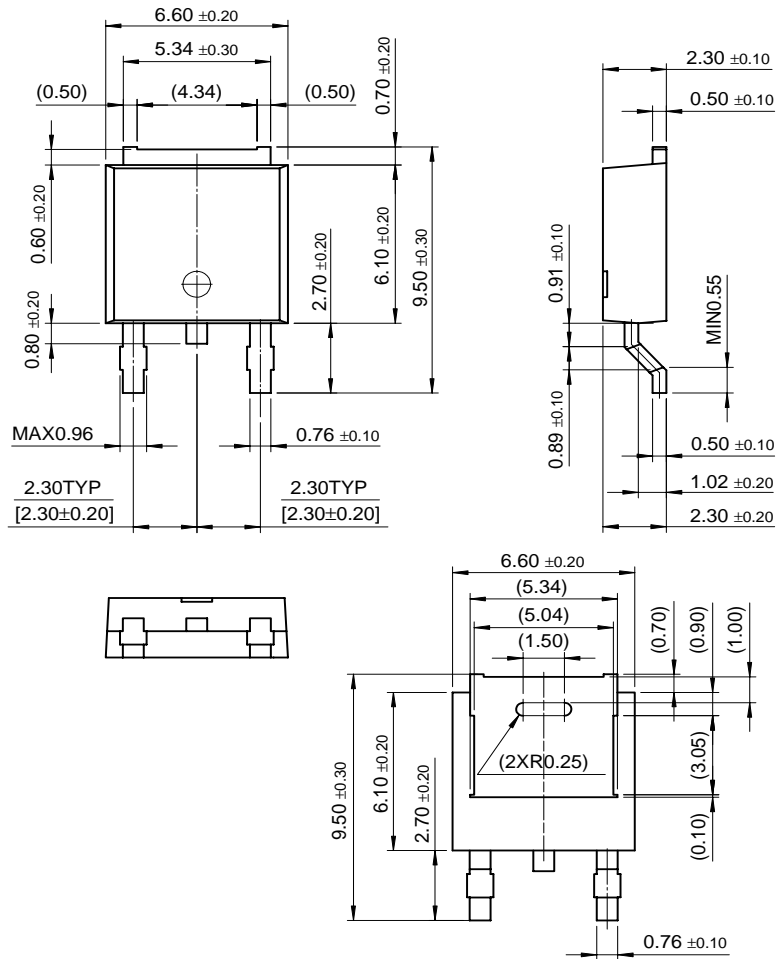

Dimensions in Millimeters

KSC5402D/KSC5402DT

## TRADEMARKS

The following are registered and unregistered trademarks Fairchild Semiconductor owns or is authorized to use and is not intended to be an exhaustive list of all such trademarks.

|  |                                 |                                |                                 |                             |
|--|---------------------------------|--------------------------------|---------------------------------|-----------------------------|
| ACE <sup>™</sup>                                 | FACT <sup>™</sup>               | ImpliedDisconnect <sup>™</sup> | PACMAN <sup>™</sup>             | SPM <sup>™</sup>            |
| ActiveArray <sup>™</sup>                         | FACT Quiet series <sup>™</sup>  | ISOPLANAR <sup>™</sup>         | POP <sup>™</sup>                | Stealth <sup>™</sup>        |
| Bottomless <sup>™</sup>                          | FAST <sup>®</sup>               | LittleFET <sup>™</sup>         | Power247 <sup>™</sup>           | SuperSOT <sup>™</sup> -3    |
| CoolFET <sup>™</sup>                             | FAST <sup>™</sup>               | MicroFET <sup>™</sup>          | PowerTrench <sup>®</sup>        | SuperSOT <sup>™</sup> -6    |
| CROSSVOLT <sup>™</sup>                           | FRFET <sup>™</sup>              | MicroPak <sup>™</sup>          | QFET <sup>™</sup>               | SuperSOT <sup>™</sup> -8    |
| DOMET <sup>™</sup>                               | GlobalOptoisolator <sup>™</sup> | MICROWIRE <sup>™</sup>         | QS <sup>™</sup>                 | SyncFET <sup>™</sup>        |
| EcoSPARK <sup>™</sup>                            | GTO <sup>™</sup>                | MSX <sup>™</sup>               | QT Optoelectronics <sup>™</sup> | TinyLogic <sup>™</sup>      |
| E <sup>2</sup> CMOS <sup>™</sup>                 | HiSeC <sup>™</sup>              | MSXPro <sup>™</sup>            | Quiet Series <sup>™</sup>       | TruTranslation <sup>™</sup> |
| EnSigna <sup>™</sup>                             | I <sup>2</sup> C <sup>™</sup>   | OCX <sup>™</sup>               | RapidConfigure <sup>™</sup>     | UHC <sup>™</sup>            |
| Across the board. Around the world. <sup>™</sup> |                                 | OCXPro <sup>™</sup>            | RapidConnect <sup>™</sup>       | UltraFET <sup>®</sup>       |
| The Power Franchise <sup>™</sup>                 |                                 | OPTOLOGIC <sup>®</sup>         | SILENT SWITCHER <sup>®</sup>    | VCX <sup>™</sup>            |
| Programmable Active Droop <sup>™</sup>           |                                 | OPTOPLANAR <sup>™</sup>        | SMART START <sup>™</sup>        |                             |

## DISCLAIMER

FAIRCHILD SEMICONDUCTOR RESERVES THE RIGHT TO MAKE CHANGES WITHOUT FURTHER NOTICE TO ANY PRODUCTS HEREIN TO IMPROVE RELIABILITY, FUNCTION OR DESIGN. FAIRCHILD DOES NOT ASSUME ANY LIABILITY ARISING OUT OF THE APPLICATION OR USE OF ANY PRODUCT OR CIRCUIT DESCRIBED HEREIN; NEITHER DOES IT CONVEY ANY LICENSE UNDER ITS PATENT RIGHTS, NOR THE RIGHTS OF OTHERS.

## LIFE SUPPORT POLICY

FAIRCHILD'S PRODUCTS ARE NOT AUTHORIZED FOR USE AS CRITICAL COMPONENTS IN LIFE SUPPORT DEVICES OR SYSTEMS WITHOUT THE EXPRESS WRITTEN APPROVAL OF FAIRCHILD SEMICONDUCTOR INTERNATIONAL.

As used herein:

1. Life support devices or systems are devices or systems which, (a) are intended for surgical implant into the body, or (b) support or sustain life, or (c) whose failure to perform when properly used in accordance with instructions for use provided in the labeling, can be reasonably expected to result in significant injury to the user.
2. A critical component is any component of a life support device or system whose failure to perform can be reasonably expected to cause the failure of the life support device or system, or to affect its safety or effectiveness.

## PRODUCT STATUS DEFINITIONS

### Definition of Terms

| Datasheet Identification | Product Status         | Definition  |
|--------------------------|------------------------|---|
| Advance Information      | Formative or In Design | This datasheet contains the design specifications for product development. Specifications may change in any manner without notice.  |
| Preliminary              | First Production       | This datasheet contains preliminary data, and supplementary data will be published at a later date. Fairchild Semiconductor reserves the right to make changes at any time without notice in order to improve design. |
| No Identification Needed | Full Production        | This datasheet contains final specifications. Fairchild Semiconductor reserves the right to make changes at any time without notice in order to improve design.   |
| Obsolete                 | Not In Production      | This datasheet contains specifications on a product that has been discontinued by Fairchild semiconductor. The datasheet is printed for reference information only.   |